

1、MECHANICAL OUTLINE(Unit: mm, Unspecified Tolerance $\pm 0.2\text{mm}$) Color: Yellow Green

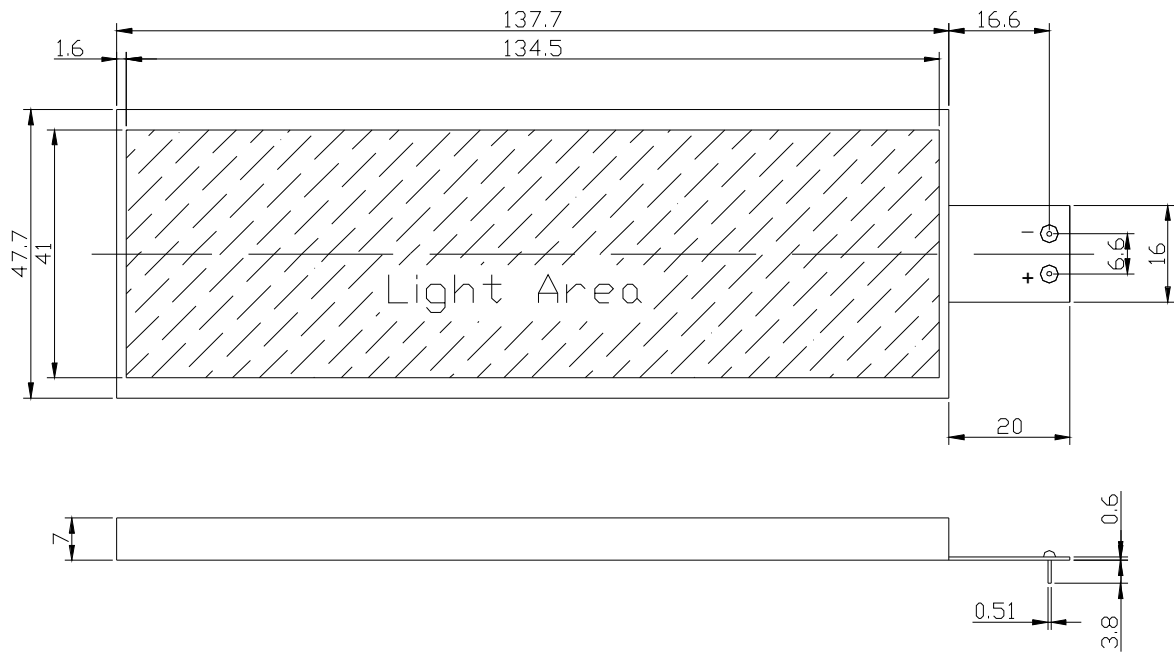

2、CIRCUIT DIAGRAM (LED 2 x 45 = 90 dies)

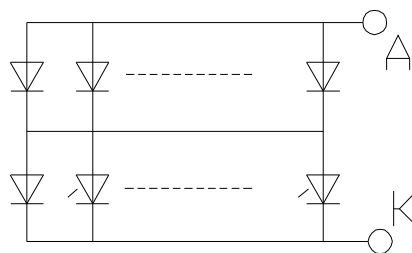

3、SOLDERING CONDITIONS:

- I The Soldering Temperature is $260^{\circ}\text{C} \pm 5^{\circ}\text{C}$ and Soldering Time should be less than 3 sec, and soldering iron power should be less than 30W.
- I The soldering point should be farther than 1.6 mm from body.

4、ABSOLUTE MAXIMUM RATINGS

Item	Symbol	Conditions	Max.	Unit
Absolute maximum forward current	Ifm		650	mA
Peak forward current	Ifp	1 msec plus 10% Duty Cycle	1300	mA
Reverse Voltage	Vr		10	V
Power dissipation	Pd		2700	mW
Operating Temperature Range	Topr		-20~+70	°C
Storage Temperature Range	Tstg		-20~+75	°C

5、ELECTRICAL-OPTICAL CHARACTERISTICS: (T=25°C)

Item	Symbol	Min.	Typ.	Max.	Unit	Condition
Forward Current	If	350	450	500	mA	Vf=4.2V
Forward Voltage	Vf	4.0	4.2	4.4	V	If=450mA
Reverse Current	Ir			500	μA	Vr=10V
Luminance	Lv		130		cd/m ²	If=450mA
Peak wave length	λp	565	568	570	nm	If=450mA